

Vexve Termomix A/C/D

3- ja 4-tie jako- ja sekoitusventiilit
 3- und 4-wege verteiler- und mischventile
 3 and 4-way distribution and mixing valves

3 och 4-vägs fördelnings- och shuntventiler
 Vannes de distribution et mélangeuses 3 et 4 voies
 3 и 4-х поточные распределительные и смешительные клапаны

Factory setting

D-model

C-model

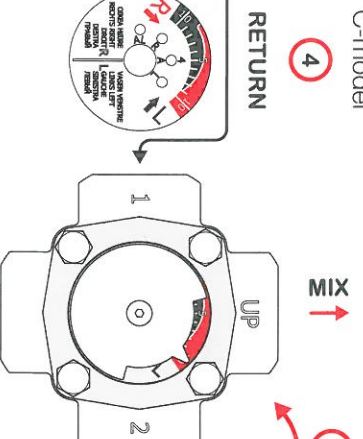
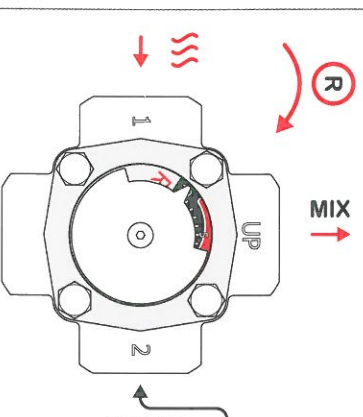
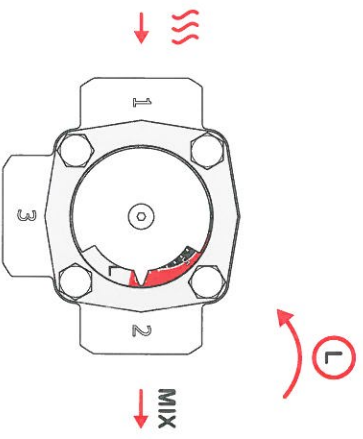
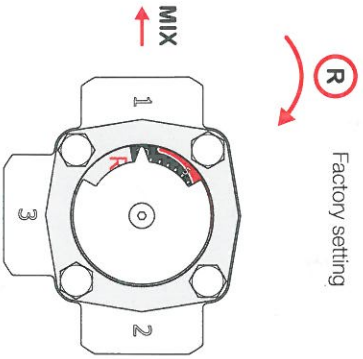

MIX ↑

MIX ↑

MIX ↑

MIX ↑

MIX ↑

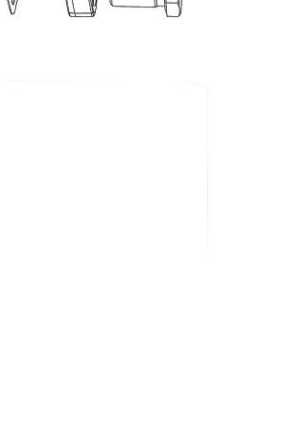
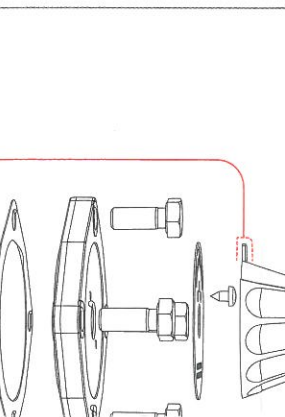
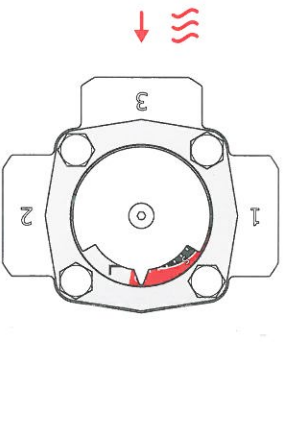
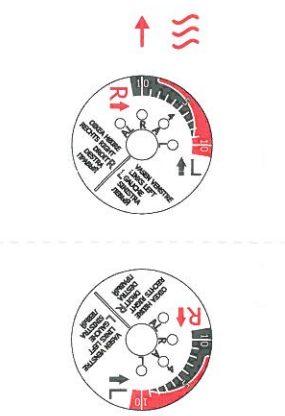
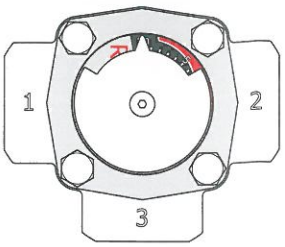

A-model

MIX ↑

MIX ↑

MIX ↓

MIX ↑

MIX ↓

