

VEXVE

Setup and User Guide for Vexve AM40 Heating and Cooling Controller 1.50 »



Table of contents

Dimensions	4
Delivery Contents	5
Accessories	5
Valve assembly	6
Connections	7
First start.....	9
Adding a wireless room unit.....	12
Adding second heating circuit	14
Basic functions.....	15
Menus.....	16
Basic screens.....	17
Measurements.....	18
Clock functions	18
Device settings.....	20
Language.....	20
Backlight	20
Relay (R1) function	21
IN4 use	23
H1 Options.....	25
H2 Options	30
ECO-transition	30
Communication	31
Information.....	31
Reset factory settings	31
Alarms.....	32
ECO and Holiday modes	33
Using the room unit.....	35
Heating curve.....	39
Applications	42
Quick setup guide	45

Note!

☆ Sections marked with a star are intended for advanced users!

☆☆ Sections marked with two stars apply only to AM40 H/C –models

Vexve AM40

Vexve AM40 is a heating controller that can be used for the regulation of two heating circuits and it can be set to operate according to the indoor or outdoor temperature. Basic delivery includes a controller and accessories for controlling one heating circuit according to the outdoor temperature.

Installing the device is very easy: Sensors and actuators are equipped with RJ-type connectors that enable fast and fault free electrical connection. AM40 is connected directly to the grid with a transformer so it is safe to install. As you turn on the AM40 control unit for the first time, the software guides you step by step through the basic settings.

The control unit can be placed in a convenient location within easy reach. On the LCD display you can see important information e.g. temperatures at one glance. Required adjustments can easily be made with easy-to-use menus.

Saving energy is simple with two different ECO functions that enable, for example, decreasing the temperature during a workday. You can switch between these functions with just the single push of a button.

AM40 includes also many pre-installed programs for different heating purposes and as well for controlling a pump or solar heating in hybrid heating systems. The relay inside the control unit can also be used for directly controlling 230 VAC pumps or contactors.

It is easy to expand AM40 with different accessory packs. You can for example add wireless room units to AM40 with which you can adjust the room temperature, check the values that AM40 has measured and access most of the device settings. It is also possible to add a GSM controller to AM40 to enable the increase or decrease of the indoor temperature with an SMS.



Delivery contents of basic delivery of AM40

Dimensions

Basic delivery of AM40

Product no. 1140040

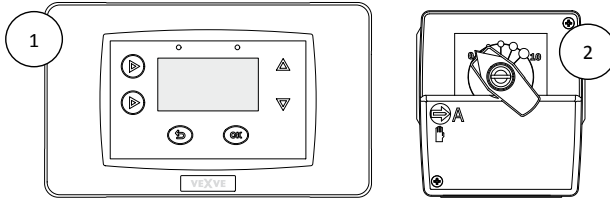

Dimensions [mm]

	CU (control unit) ①	MU (motor unit) ②
Width	167	77
Height	94	90
Depth	36	87 (with the manual handle installed)

Pack A – Wireless room unit and RF-transmitter

Product no. 1140041

(accessory)

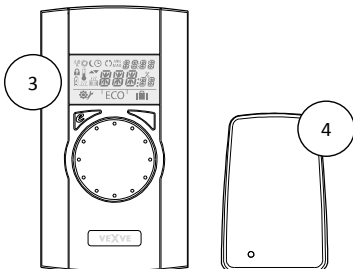

Dimensions [mm]

	RU (room unit) ③	RF (RF unit) ④
Width	78	55
Height	139	83
Depth	23	15

Delivery Contents

Basic Delivery

Picture on page 3

- **AM40 control unit** // *Product no. 1940003*
Picture 1 on page 4
 - **Motor unit** // *1920616*
Picture 2 on page 4
 - with 1,5 meter cable, RJ-12 connector
 - **Power supply** // *1920128*
 - 230 VAC/18 VAC
 - with 2,5 meter cable
 - **Outdoor temperature sensor (NTC), 15 meters, RJ-11** // *1920132*
 - with wall mount box
 - **Supply water sensor (KTY), 3 meters, RJ-11** // *1920133*
 - with pipe attachment ties
 - **Adapters for Vexve AMV and Termomix type valves** // *1920617*
-

Accessories

It is easy to expand AM40 with different accessory packs:

Pack A – Wireless room unit and RF-transmitter

// *1140041* // *EAN 6415843670558*

- **Wireless room unit**
Picture 3 on page 4
 - three (3) alkaline AA batteries included
- **RF transmitter**
Picture 4 on page 4
 - with 2 meter wire

Pack B – Motor package for heating circuit 2

// *1140042* // *EAN 6415843670565*

- **Motor unit, 1,5 meter cable, RJ-12** // *1920616*
- **Supply water sensor (KTY), 3 meters, RJ-11** // *1920133*
- **Adapters for Vexve AMV and Termomix type valves** // *1920617*

Pack C – Additional room unit for second heating circuit

// *1140043* // *EAN 6415843670572*

- **Wireless room unit**
 - three (3) alkaline AA batteries included

NOTE! Uses the RF-transmitter of Pack A

Pack D – GSM module * // *1140044*

For example for switching on ECO mode with an SMS.

Pack E – Bio loading package * // *1140045*

Enables adding a solid fuel boiler, fireplace etc. to storage tank.

Pack F – Solar heating package * // *1140046*

Enables connecting solar collectors to storage tank.

*For more information contact Vexve customer service

Extra micro limit switch // *1920745*

Enables for example pump control according to valve position. Mounted inside the motor housing.

Max load: 230 VAC, max. 100 W pump.

Sensors

KTY sensor, 4-pole, 3 meters, RJ-11 // *1920133*

Can be used as a supply or return water temperature sensor. Max. temperature 100 °C. Fits the inputs IN1 and IN2.

NTC sensor, 4-pole, 15 meters, RJ-11 // *1920132*

Can be used as an outdoor temperature sensor. Fits the input IN3.

PT1000 sensor, 2-pole, 3 meters // *1920562*

Withstands high temperatures (max. 200 °C). Can be used for example as a solar collector sensor. Fits the input IN4.

KTY sensor, 2-pole, 5 meters // *1920023*

Max. temperature 100 °C. Fits the input IN4.

Valve assembly

1. Check the rotation direction of the valve. By default the valve opens clockwise
2. Position the valve to zero and remove the knob.
3. Install the adapter on the valve stem and make sure that it is fully in place:

Vexve AMV series with two-point fastening:

A pin is preinstalled at the left edge of the valve, and only the Termomix adapter from the installation kit needs to be installed on the stem. The pin can be installed on the other side as required by the position of the motor.

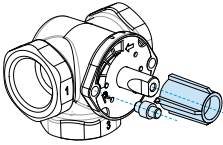

Termomix valves and AMV and ABV series valves with four-point fastening:

Install the correct rotation-preventing screw and adapter from the installation kit.

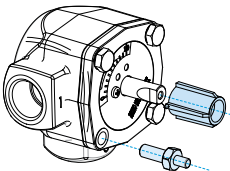

4. Make sure that the switch on the front side of the motor unit is set to manual operation (points to the hand symbol) and check that the **motor is also positioned to zero** = it has the same position as the valve.

5. Install the motor unit on the valve.

Use the handle to check that the valve-motor combination turns 90 degrees with reasonable torque

6. Install the two-sided indicating panel in place so that the indicator of the handle points at the zero position when the valve is closed.
7. Tighten the screw to fasten the motor in place and rotate the handle to check that the valve can easily be turned 90 degrees.

Leave the equipment at the zero position and set the switch on front side of the motor unit to automatic operation (A).

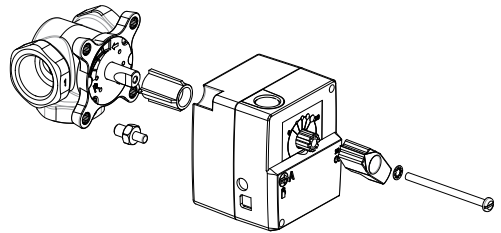

NOTE! There are also installation kits available also for other manufacturers' valves!

E.g. Installation kit for the Esbe VRG valve (product number 1920117).

Good to know: If the valve remains in the same position for 24 hours, it will automatically be rotated in order to prevent it getting stuck. This will be done so that the limits of supply water temperature won't be exceeded.

Connections

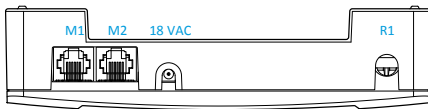
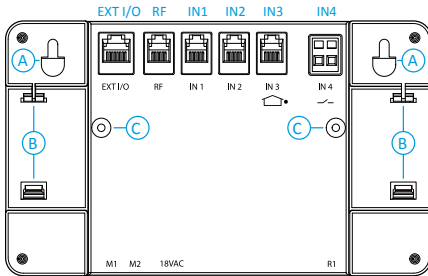

1. Connect motor unit of heating circuit 1 to M1 connector.

If there are two heating circuits in use, connect the motor unit of heating circuit 2 to M2 connector (Pack B – Motor package for heating circuit 2//Product no. 1140042).

2. Fasten supply water sensor to pipeline about 5-50 cm from mixing valve with the fastening ties. If the sensor is placed too near, conduction of heat might affect the measurements. Attach the sensor cable to the IN1 connector.

If heating circuit 2 is in use, fasten the sensor the same way to the pipeline and connect sensor cable to the IN2 connector.

If there is just one heating circuit in use, return water sensor can be attached to IN2 connector. Product no. 1920133

RF	RF transmitter
IN1	Supply water temperature sensor of 1-circuit
IN2	Supply water temperature sensor of 2-circuit Only one circuit in use: return water sensor of 1-circuit
IN3	Outdoor temperature sensor
IN4	Contact info (away switch) /sensor
R1	Potential free relay 0, 5 Amp inductive, screw contact (only for professional electrician) Cover must be opened to access R1 relay.
M1	Motor unit 1-circuit
M2	Motor unit 2-circuit
18 VAC	External power supply
EXTI/O	External data connection
A	Wall mounts with screws
B	DIN rail connectors
C	Fastening screws for the back cover

3. Attach the outdoor temperature sensor to a suitable place on the outer wall by using the wall mount box. Choose a sheltered location for the sensor: northern wall, no direct sunlight, snow or rain to sensor box, away from possible heat sources e.g. air ventilation valve.

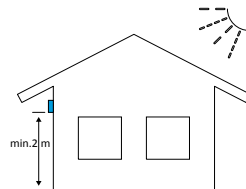

Attach the sensor cable to the IN3 connector.

If necessary, the sensor cable can easily be extended by using a ready-to-use 10 meter extension cable (product number 1920096).

NOTE! Connecting point of cable lengthening must be located inside the building!

4. If you are using a wireless room unit (*Pack A – Wireless room unit and RF-transmitter//Product no. 1140041*):
 - Connect RF transmitter to RF connector
 - Place RF transmitter as high as possible.

If necessary, the RF transmitter cable can be lengthened with a ready-to-use 10 meter extension cable (product number 1920096).

NOTE! The power cable **MUST NOT** run next to the RF transmitter or its cable!

5. Relay control is used for example for pump control, in which case 230 VAC wire must be connected through R1 connector by opening the back cover of AM40 CU with removal of the fastening screws C. More information about relay use on page 21.

NOTE! 230 VAC connections must be done by a professional electrician!

6. IN4 connector can be used for temperature sensor or switch info. More information in "IN4 use" on page 24.
7. Attach AM40 CU with included assembly parts to a convenient location:
 - The device can be attached to the wall with the screws included
 - There are also 35 mm DIN-rail connectors on the backside of the AM40 CU

First start

When you start AM40 for the first time, the device asks for basic information.

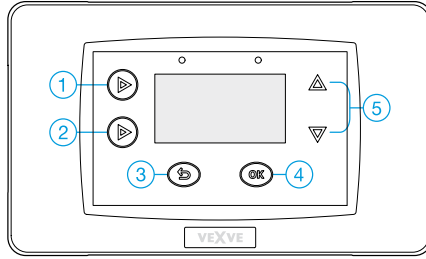

- Browse the options with the up/down keys (5)
- Confirm selections with the OK key (4)
- Move backwards in menus with the return key (3)

Below is shown the menu tree that you will follow when you turn AM40 on for the first time:

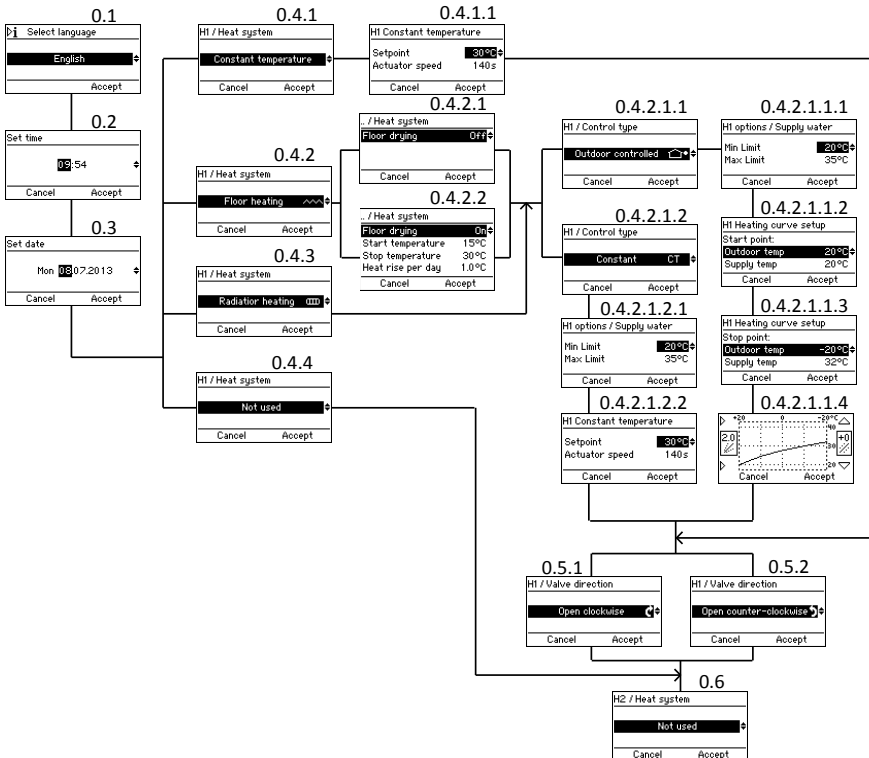

Select language

Screen 0.1 on page 9

Choose a language from 13 alternatives: English, Finnish, Swedish, German, French, Russian, Danish, Czech, Slovak, Dutch, Romanian, Italian and Estonian.

Pushing key 1 in this screen, accesses an information screen with the following information about the device:

- Application
- Software version
- Parameter version
- Hardware version

Set time

Screen 0.2

Set date

Screen 0.3

Heat system

Choose the heat system from four alternatives:

1. Constant temperature (CT)

Screen 0.4.1

CT maintains supply water temperature constant. It is suitable for example for **industrial applications** such as bio-loading or warm-air heating.

After you have chosen CT, you have to set "setpoint" for the desired temperature of supply water, and actuator speed (default speed in standard delivery is 140 sec).

If you want to keep supply water temperature constant in case of a **normal heating circuit**, choose either floor (0.4.2) or radiator heating (0.4.3) as heat system and set "Constant CT" (0.4.2.1.2) as control type. See next section "Floor heating".

2. Floor heating

Screen 0.4.2 on page 9

2.1 Floor drying function

Screen 0.4.2.2

You can activate a floor drying function, that is in accordance with the standard EN1264-4.

- **Start temperature:** set the supply water temperature setpoint when drying starts
- **Stop temperature:** set the supply water temperature setpoint when drying stops
- **Heat rise per day:** set the daily change in supply water temperature setpoint

For example:

Start temperature = 15 °C, Stop temperature = 30 °C, Heat rise per day = 1 °C

>> Heating is started at 15 degrees, and the setpoint temperature is increased one degree each day until it reaches 30°C. After this, the setpoint temperature is decreased one degree per day until it reaches 15°C.

2.2 Control type

Choose the control type (outdoor controlled or Constant CT):

2.2.1 Outdoor controlled

Screen 0.4.2.1.1

The device adjusts supply water temperature according to outside temperature by using the heating curve which you set in screens "Heating curve setup" (0.4.2.1.1.2 - 0.4.2.1.1.4)

2.2.1.1 Supply water

Screen 0.4.2.1.1.1

Set maximum and minimum limits for the supply water temperature or accept factory default settings

2.2.1.2 Automated heating curve setup

There are three steps in the automated heating curve setup:

Start point

Screen 0.4.2.1.1.2

Summertime outdoor temperature (5 - 20 °C) and corresponding supply water temperature at the starting point of the curve

Stop point

Screen 0.4.2.1.1.3

Wintertime outdoor temperature (-5 - -30 °C) and corresponding supply water temperature at the ending point of the heating curve

Graphical view

Screen 0.4.2.1.1.4 on page 9

Shows the curve which AM40 has generated based on the given start and stop points, applying the minimum and maximum settings.

You can edit curves (0.2 – 9.5) with keys 1 and 2 on the left side of the AM40 CU. Curves from 0.2 to 5.0 can be chosen in steps of size 0.2 and curves from 5.0 to 9.5 in steps of 0.5. Default curve for floor heating is 2 and for radiator heating 4.

With the up/down keys (5) on the right side you can set the offset of the curve. This means that you move the curve up or down as a whole without changing its gradient. This should not be used when you use AM40 for the first time!

More information about heating curves on page 39.

2.2.2. Constant CT

Screen 0.4.2.1.2 on page 9

Supply water temperature is kept constant.

2.2.2.1 Supply water

Screen 0.4.2.1.2.2

Set maximum and minimum limits for the supply

water temperature or accept the factory default settings

After you have chosen CT as control type and set supply water temperature limits, you need to set “setpoint”, the desired temperature of supply water, and actuator speed (default speed of standard delivery is 140 sec).

3. Radiator heating

Screen 0.4.3 on page 9

In case of radiator heating you also have to choose the control type (outdoor controlled or Constant CT) and set temperature limits for the supply water just the same way as it is chosen for floor heating, see chapter “2.2 Control type” on page 10

4. Not used

Screen 0.4.4 on page 9

Heating circuit 1 not installed

Valve direction

Set the rotation direction of the valve:

Opens clockwise (0.5.1) or counter-clockwise (0.5.2)

H2 Options

Screen 0.6 on page 9

*Pack B – Motor package for heating circuit 2//
Product no. 1140042*

If you use two circuits you can now give the basic information for the second circuit just the way you did for the first circuit.

It is also possible to add the second circuit later.

If you are using just one circuit, or H2 is used in cooling application ☆ ☆ with H1, select “Not used”.

Adding a wireless room unit

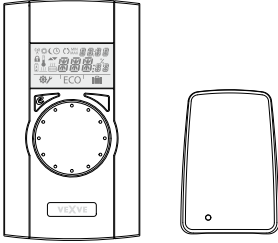

*Pack A – Wireless room unit and RF-transmitter//
Product no. 1140041*

*Pack C – Additional room unit for second heating
circuit// Product no. 1140043*

Note! Uses the RF-transmitter of Pack A

Connections

1. Connect the RF transmitter to RF connector on the backside of AM40 CU.
2. Place the RF transmitter as high as possible. If necessary, the RF transmitter cable can be lengthened with a ready-to-use 10 meter extension cable (product number 1920096).
3. Slide the back plate of the wireless room unit down to remove it. Remove the plastic protecting the batteries and check that “RU” appears on the display of wireless room unit.

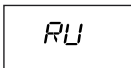

If there is something else on the screen, use a ballpoint pen to push the button on the back panel of the wireless room unit to enter the setup menu. In the setup menu, choose “DEFA” by rotating the knob and select “YES” after which “RU” appears on the display.

Pairing the devices

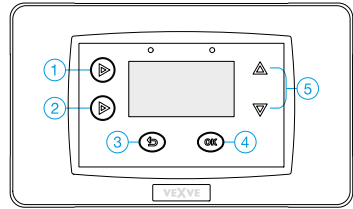

- Browse options with up/down keys (5) and confirm selections with the OK key (4). With the return key (3) you can move backwards in the menus.

1. Press key 1 on the AM40 CU as many times until you reach “Main menu”. Follow the menu tree shown on next page (Main Menu >> Device settings >> Communication >> RF-devices >> Device Pair up).
2. When you have reached the “Device pair-up” (screen 4.2.9.2.1) on page 13, push the OK key (4) on the AM40 CU.
3. Push immediately the right-hand button on the wireless room unit.

On the display of wireless room unit appears text “PAIR” and on the display of AM40 CU “Device pair-up”.

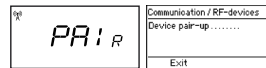

- After a while text "PAIR OK" appears on the display of the wireless room unit and "Found: AM Room unit" on the display of the AM40 CU.

Now you must choose the heating circuit (H1 for heating circuit 1/H2 for heating circuit 2) which the room unit controls.



NOTE! You have to confirm pairing in both devices!

After these steps all the basic data will be copied from the AM40 CU to the wireless room unit.

You can leave the pairing menu in the wireless room unit by pressing the right-hand button. You move to the setup menu. **You don't have to make any changes to the settings since the data is copied automatically from AM40 CU.**

However, if you want to make some changes in the setup menu, navigate the menu by rotating the round knob and push the right-hand button to modify an option. Select the desired value by rotating the round knob and confirm the change by pushing the right-hand button.

Leave the setup menu in the wireless room unit by pressing the left-hand key.

On page 35 you can find information about using the wireless room unit.

Info about changing outdoor control to indoor control can be found on pages 26 and 27

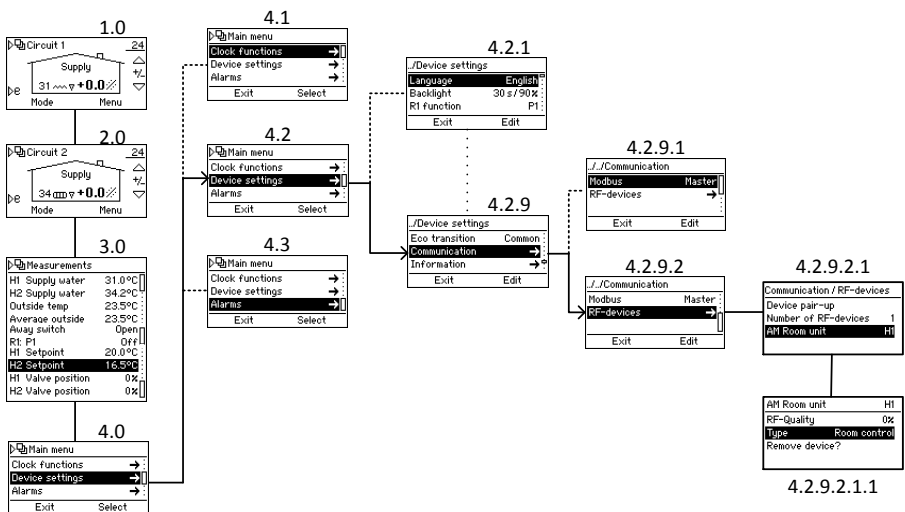

Adding second heating circuit

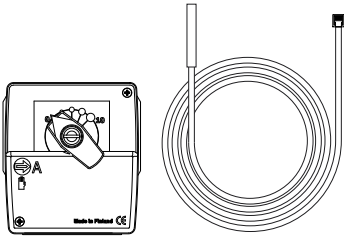

Pack B – Motor package for heating circuit 2//
Product no. 1140042

See, for example, drawing “2. Basic 2-circuit” on page 42

Mechanical assembly

Mechanical assembly is the same as in the case of circuit 1, see page 6.

Connections

1. Connect the motor unit of heating circuit 2 to M2 connector.
2. Fasten the supply water sensor to pipeline 5-50 cm from the mixing valve with the fastening ties. Attach the sensor cable to the IN2 connector.

Settings

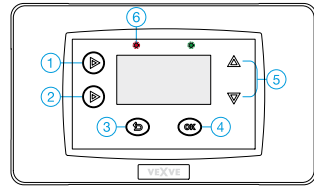

Browse options with up/down keys (5) and confirm selections with the OK key (4). With return key (3) you can move backwards in menus.

Press key 1 shortly as many times until you reach “Main menu” and follow the menu tree shown below to reach “H2 Options” where you can give information for heating circuit 2.

Options for heating circuit 2 are the same as for heating circuit 1 **except** “Return temperature prioritization”, “Modulation ΔT” and “Cooling function” are available only for heating circuit 1. See “H1 Options” beginning from page 25.

Good to know: Both heating circuits can be controlled with wireless room units. In this case you need accessories Pack A and Pack C, see “Accessories” on page 5

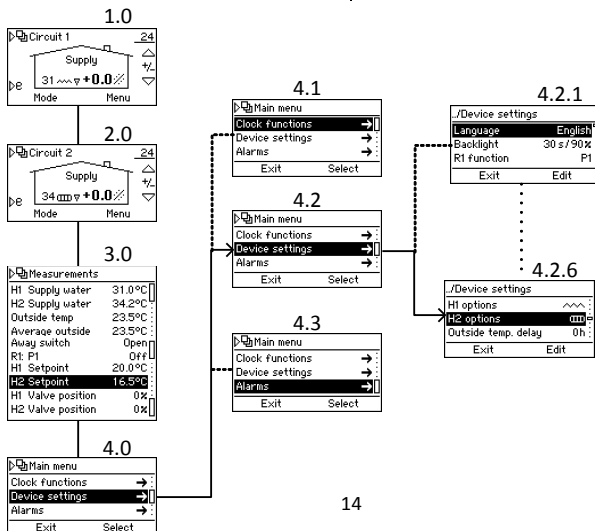

Basic functions

In a normal situation the basic screen of circuit 1 is visible on the screen. Below you can see the basic functions of the keys. Each black bullet describes a push of the key in question

Key 1

- **Basic screens** of circuit 1 and circuit 2 (see page 17)

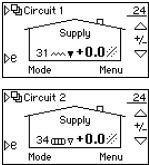

- **Measurements** - values that AM40 has measured. In order to see all the measurements, browse values with up/down keys (5)

Measurements	
H1 Supply water	31.0°C
H2 Supply water	34.2°C
Outside temp	23.5°C
Average outside	23.5°C
Awag switch	Open
Rt Ft	Off
H1 Setpoint	20.0°C
H2 Setpoint	16.5°C
H1 Valve position	0%
H2 Valve position	0%

- **Main Menu**

Main menu	
Check functions	→
Device settings	→
Alarms	→
Exit	Select

LED (6)

- Blinking **red LED** is a sign of an active alarm.
→Go to “Main menu” (key 1) and select “Alarms” to see what is causing the alarm.
More information about the alarms on page 32
- Continuously burning **green LED** is a sign of device pair up
- Continuously burning **orange LED** indicates purging of valve or pump

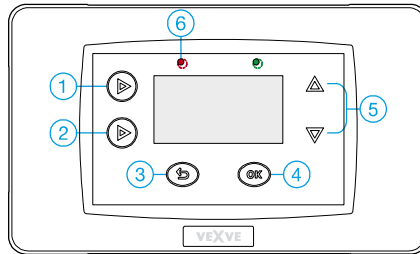

Keys 5

= **Up/down keys in menus**

- For easy room temperature adjusting. Set desired change [°C] in room temperature (room unit not in use) or the desired actual room temperature (room unit in use)

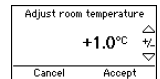

Key 2

- One short push: ECO-mode on

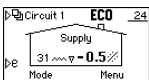

- One long push (over 3 sec): Holiday-mode on

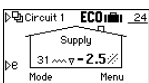

You can cancel ECO- and Holiday-modes by pressing key 2 again

More information about ECO and Holiday-modes on page 33

Key 3

= **Return key in menus**

- **Mode** – For easy checking of the values of Eco-modes.
- You can activate a selected ECO-mode
- When cooling function is activated you can choose manual heating/ cooling or automatic mode

Select mode	
Eco mode	-0.5°C / 8h
Holiday mode	-2.5°C / 30 d
Normal mode	+0.0°C
Cancel	Select

Key 4 = OK key in menus

- **Menus** of circuit 1 and circuit 2

- If there is basic screen of circuit 1 visible you move to circuit 1 menu and vice versa:



- For changing the curve settings (see page 39) and editing values of ECO- and Holiday-modes (see page 33)

NOTE! If room controlled system or heating type CT is in use, AM40 does not use a heating curve and therefore curve settings are not visible here!

Menus

Below you can see the menu tree that you find behind Key 1.

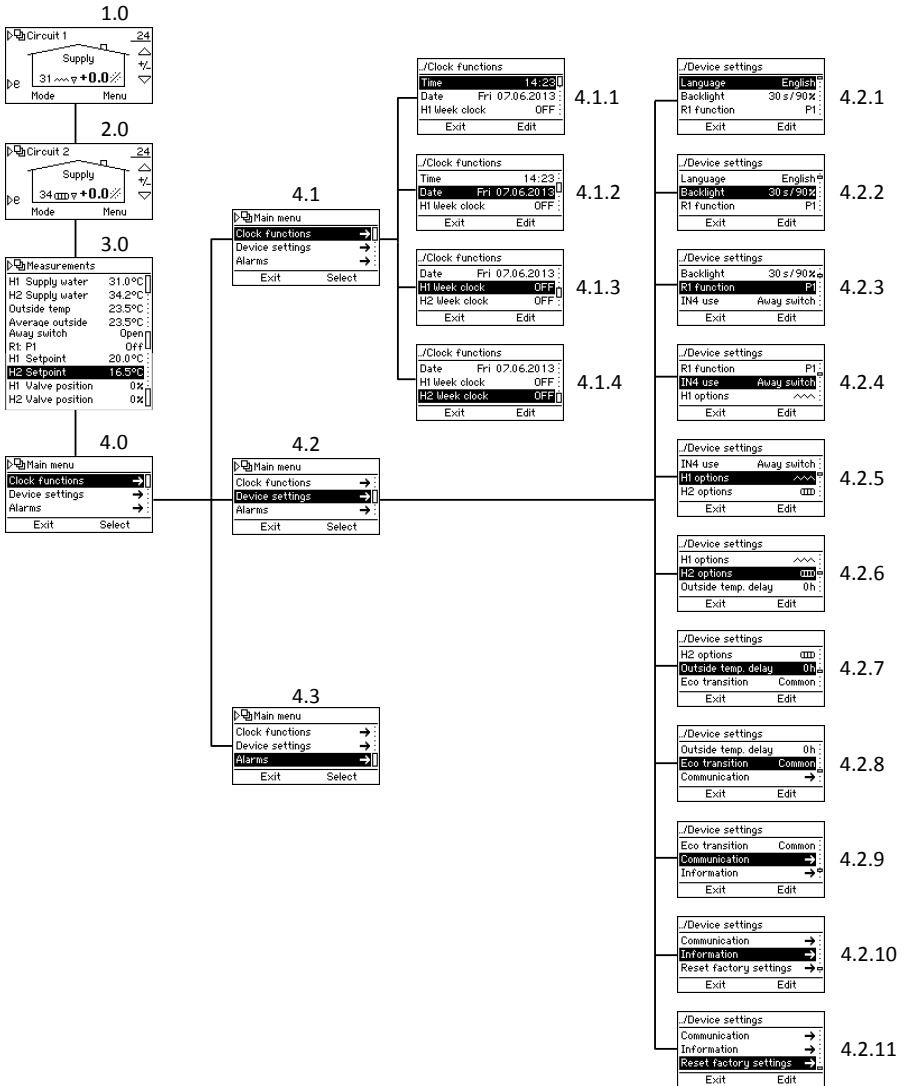

Basic screens

Screens 1.0 and 2.0 on page 16

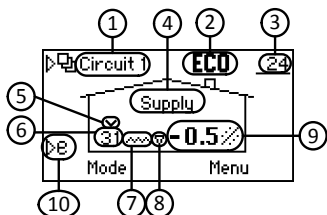

In the basic screen you can see information about the heating circuit:

		Symbols	Meaning	See page
1	Heating circuit	Circuit 1	Basic screen of heating circuit 1	25
		Circuit 2	Basic screen of heating circuit 2	30
2	Mode of the circuit	No symbol	Normal	
			Day program	18
			Night program	18
			Week clock: OFF-mode on	19
		ECO	ECO mode	33
		ECO	Holiday mode	33
		ECO EXT	ECO mode activated with an external switch	33
3	Outdoor temperature	<u>23</u>	Underlined outdoor temperature >> outdoor controlled system	26
		- - -	Problem with outdoor temperature sensor	32
4	Control type	Supply	Outdoor controlled system	26
		Room	Room unit is in use >> Outdoor controlled system with room compensation OR room controlled system. Underlined temperature indicates the control type, see points 3 and 9.	27
		Constant	Heating type is constant temperature (CT)	26
	Floor Drying	Dry	Floor drying is on	26
5	Limitation of supply water temperature		Prioritization of return water temperature limits the supply water temperature	27
6	Supply water temperature	- - -	Problem with the supply water temperature sensor	32
7	Heating type		Radiator heating	26
			Underfloor heating	26
		No symbol	Constant temperature (CT) >> Note word "Constant" in section 4!	26
			Displayed above heating symbol when heating is required	
	Domestic hot water heating		Domestic hot water heating on	22
8	Heating need		Supply water temperature rising towards setpoint	Black when motor is running
			Supply water temperature dropping towards setpoint	
9	Setpoint of room temperature OR desired change of room temperature	<u>21.0</u> °C	Underlined room temperature >> room controlled system	27
10	Quick key to Eco and Holiday modes			33

Measurements

Screen 3.0 on page 16

In "Measurements" you can check values that AM40 has measured:

- Temperature of supply water of H1
- Temperature of supply water of H2 or temperature of return water (Only if return water sensor is in use!)
- Outside temperature
- Average outside temperature
- Position of away switch or temperature of IN4
- Relay function
- Setpoint
 - o Here you can see things that influence the value of setpoint
- Calculated valve opening [%]

NOTE! All the values that are visible in screen 3.0 are not displayed if only one heating circuit is in use!

Clock functions

Screen 4.1 on page 16

In clock functions you can change time and date settings and activate and program different week clock programs. With these programs you can easily save energy: You can for example set a temperature drop for night-time.

You can choose a program from three different alternatives:

(screen 4.1.3 for circuit 1 and 4.1.4 for circuit 2)

- 5 – 2: You can set a program separately for weekdays and weekends
- 7 – 0: Same program for every day
- 7 – 7: You can program various different programs and set many temperature changes even for one day

Programming 5 – 2 and 7 - 0 week clocks

Browse options with up/down keys (5) and confirm selections with the OK key (4). With the return key (3) you can move to the previous selection.

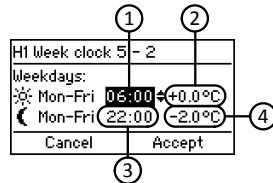

1. Set the time you want the daytime temperature drop/increase to come into effect. Default: 06:00
2. Set temperature change (room unit not in use) or actual room temperature (room unit in use) for the daytime during weekdays. Default: 0.0 °C/21.0°C
3. Set the time you want the nighttime temperature drop/increase to come into effect. Default 22:00
4. Set temperature change or actual room temperature for the nighttime during weekdays. Default: -2.0 °C/ 19.0°C

Push down key (5) to reach weekend options. Set time and temperature settings the same way as for weekdays.

Default: Daytime: 08:00/0.0 °C or 21.0°C, nighttime: 23:00/-2.0 °C or 19.0 °C

The principle of 7-0 programming is the same as in 5-2, except the temperature changes and starting times are the same for everyday from Monday through to Sunday.

Programming 7 – 7 week clock

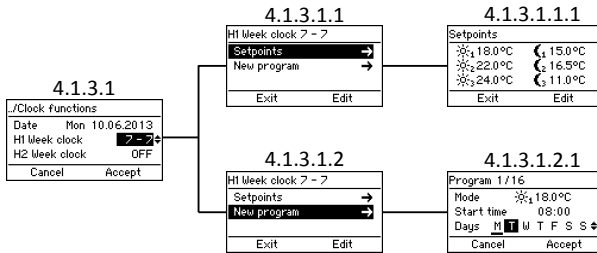

- In “Setpoints” (screen 4.1.3.1.1) you can set 6 different setpoint temperatures
 - Choose a temperature with up/down keys (5) and accept it with OK key (4)
- In “New program” (screen 4.1.3.1.2) you can create a new program:
 - In “Mode” you choose one of the setpoints you have set in “Setpoints”
 - OFF-mode means that heating turns off: Valve closes and pump shuts down.
 - **NOTE!** If outdoor temperature is less than +0,5 °C, the pump will not shut down and valve will not close, but the heating circuit will run with the minimum parameters
 - In “Start time” you set the time you want the chosen setpoint to be activated
 - In “Days” you choose the days when you want the program to be on: Choose a day by pressing up/down keys – selection is active when the letter is underlined. Confirm selection and move forward by pressing OK key (4).

- In “Check programs” you can see daily programs: Setpoints and the time when they are activated. You can browse the days with the upper left-hand key (1)
- In “Remove program” you can remove

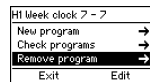

programs

NOTE! “New program” (screen 4.1.3.1.2) is not visible if every program is already in use! “Check program” and “Remove program” are not visible if you have not programmed any programs!

Device settings

Screen 4.2 on page 16

In device settings you can change most of the settings.

Language

Screen 4.2.1

In "Language" you can choose a language of 13 alternatives: English, Finnish, Swedish, German, French, Russian, Danish, Czech, Slovak, Dutch, Romanian, Italian and Estonian.

Backlight

Screen 4.2.2

Set "Delay" - the time (5-180 sec) after which the backlight will go out if the device is unused.

- If you don't want to use backlight at all, choose "Always OFF"
- if you want it to be always on, choose "Always ON"

Set "Brightness" - the percentage value of the maximum brightness of the backlight

Relay (R1) function

Screen 4.2.3 on page 16

In “R1 function” you can set a function for the relay.

4.2.3

./Device settings	Backlight 30 s / 90 x
./Relay function	IN4 use Away switch
Exit	Edit

./Relay function	Not used	4.2.3.1
Cancel	Accept	
./Relay function	Eco: External switch info when Eco or Holiday is activated	4.2.3.2
Cancel	Accept	
./Relay function	P1: Circulation pump control for circuit 1	4.2.3.3
Cancel	Accept	
./Relay function	P2: Circulation pump control for circuit 2	4.2.3.4
Cancel	Accept	
./Relay function	Alarm: External switch when any alarm is active	4.2.3.5
Cancel	Accept	
./Relay function	Summer stop: By outside temperature 18°C	4.2.3.6
Cancel	Accept	
./Relay function	BIO-loading: Loading temperature 60°C	4.2.3.7
Cancel	Accept	
./J.R1 function	Freeze protection: Set point 10°C Hysteresis 3°C	4.2.3.8
Cancel	Accept	
./J.R1 function	Domestic hot water heating: Set point 50°C Hysteresis 10°C	4.2.3.9
Cancel	Accept	
./J.R1 function	Temperature difference: ON IN4 - IN2 >3°C OFF IN4 - IN2 <3°C	4.2.3.10
Cancel	Accept	
./J.R1 function	Controlled by AHS0:	4.2.3.11
Cancel	Accept	
./J.R1 function	Manual operation: Relay state: Off	4.2.3.12
Cancel	Accept	
./J.R1 function	Burner control: Outside low limit -18°C Hysteresis 3°C	4.2.3.13
Cancel	Accept	

Not used

4.2.3.1

Relay not in use

ECO

4.2.3.2

External switch info when Eco or Holiday mode is activated

P1 and P2

4.2.3.3 & 4.2.3.4

P1= Circulation pump control for circuit 1,
P2 = Circulation pump control for circuit 2:
Pump starts immediately if there is need for heating in heating circuit.

You have to choose if the pump is a standard or a low energy pump. If you use a low energy pump you have to set a start delay, which is the minimum time that the pump remains shut after it is turned off.

Good to know: If the pump remains shut for 24 hours, it will automatically be started for 5 minutes.

Emergency stop function – see page 23

Alarm

4.2.3.5

External switch info when any alarm is active.

For example:

Pack D – GSM module//product number 1140044
Relay closes if any alarm is active and an error SMS will be sent to the chosen phone number.

Summer switch

4.2.3.6

Heating stops when outdoor temperature rises above a certain temperature that you set yourself in this selection.

Emergency stop function – see page 23

BIO-loading ☆

Screen 4.2.3.7 on page 21

Drawing 3 on page 42

The BIO-loading function enables loading the accumulator with the help of an external boiler.

Sensor (product number 1920023) must be connected to the IN4 connector. Check that the type of IN4 input is KTY, see "IN4 use" on page 24.

You have to set a "Loading temperature" which is the temperature limit for water in the boiler (IN4 in the drawing). Loading will be automatically started by turning on the pump when the limit is exceeded and stops if temperature drops at least 5 °C below the limit.

Loading can also be started before the limit is reached in case the temperature has risen enough during the last 30 minutes.

Freeze protection ☆

Screen 4.2.3.8 on page 21

With this function you can control the relay according to temperature.

In "Set point" you set temperature limit and if the temperature drops under it, the relay opens or closes depending on your selection whether the relay is normally closed or open – in case it is normally open it closes when temperature drops under the limit.

In "Hysteresis" you set the temperature range between closing and opening the relay – relay closes/opens when temperature drops below the set point and remains closed/open until the temperature has risen above the set point by the amount of hysteresis.

In "Sensor" you choose the sensor (IN1-IN4) that measures the wanted temperature.

NOTE! If you use IN4 input, you must configure the input according to the sensor type that you are using >> See "IN4 use" on page 24.

Domestic hot water heating ☆

Screen 4.2.3.9 on page 21

Drawings 6 and 8 on page 43: Relay controls the domestic hot water pump

Drawings 7 and 9 on page 43: Relay controls the change valve

In "Set point" you set the minimum limit for accumulator temperature. If the temperature is below this limit, accumulator will be loaded with the hot water from the boiler.

In "Hysteresis" you set the temperature range between starting and ending points of loading – loading starts when the temperature is below the setpoint and goes on until the temperature has risen above the setpoint by the amount of hysteresis.

In "H1 while loading" you can choose whether the valve is closed or opened when the loading is on.

In "Sensor" you choose the sensor input which is used for measuring the accumulator temperature.

NOTE! If you use IN4 input, you must configure the input according to the sensor type that you are using >> See "IN4 use" on page 23.

Temperature difference ☆

Screen 4.2.3.10 on page 21

In “ON” you set the limit for temperature difference between IN4 and IN2 - when difference is bigger than this, loading of accumulator starts.

In “OFF” you set the temperature difference between IN4 and IN2 - when difference is smaller than this, loading of accumulator stops.

For example

Drawing 4 on page 42

“ON IN4 - IN2” > 8 °C

“OFF IN4 - IN2” < 3 °C

Loading of accumulator starts when temperature difference between collector sensor (IN4 in the drawing) and accumulator (IN2 in the drawing) is more than 8 degrees.

When the difference decreases below 3 degrees, loading stops.

NOTE! Both IN2 and IN4 must be unused; if one or both of them are in use, this selection is not available.

Collector sensor (IN4) must be a PT1000 sensor (product number 1920562) so that it can withstand high temperatures!

Configure the IN4 input according to the sensor type you are using >> See “IN4 use”.

Pump emergency stop function

If the relay controls the pump – chosen R1 function (page 21) is P1, P2 or summer switch - an emergency stop function is in use. This means that in case the supply water temperature rises 10 °C above its maximum limit the pump will stop. It remains stopped for 15 minutes before it is started again. If the temperature is still above the maximum temperature, the pump will be stopped again.

Controlled by AM50 ☆

4.2.3.11 on page 21

Vexve AM50 is an extensive control system that includes many programs for various purposes like district heating.

Manual operation ☆

4.2.3.12 on page 21

Manual use of the AM40 relay

Burner control ☆

4.2.3.13 on page 21

With this function you can control the burner.

For example

Drawing 17 on page 44

Air to water heat-pump is connected directly to the old boiler. The heat-pump just loads boiler, but AM40 controls the burner according to the rules below:

In “Outside low limit” you set temperature limit and if temperature drops under it, the relay closes and starts the burner.

In “Hysteresis” you set the temperature range between the closing and opening of the relay – relay closes when temperature drops below the set point and remains closed until the temperature has risen above the set point by the amount of hysteresis.

In “Boiler low limit” you set temperature limit and if the temperature drops under it, the relay closes and starts the burner.

In “Boiler sensor” you choose the sensor (IN2 or IN4) that measures the boiler temperature.

In “R1 Legionella function” // “Activity” you choose if you want to use legionella function, this heats the boiler up-to 65 °C to prevent legionella.

In "Period" you set activation frequency in days, default is 14days.

In "Start time" you select start time of first activation.

NOTE! If you use IN4 input, you must configure the input according to the sensor type that you are using >> See "IN4 use" below.

IN4 use

Screen 4.2.4 on page 16

The IN4-input can be configured as temperature sensor or switch info. Alternatives are:

- PT1000 – sensor ☆
Product number: 1920562
Withstands high temperatures and is suitable for example as a solar panel sensor
- KTY - sensor ☆
Product number: 1920023
Temperature sensor
- Away switch
In "Away switch polarity" you set the mode of the switch: normally open (NO) or normally closed (NC). In case the mode is "NO", Away mode is activated as the switch closes and vice versa.
For example Pack D - GSM module, product number: 1140044
- RU (ON/+0) ☆
ON/OFF room thermostat. Defines if the thermostat is normally open or closed. Set the offset for the supply water temperature which will come into effect as the thermostat becomes active. Define if the thermostat is for heating circuit 1, 2 or both.
- Condense switch ☆ ☆
Used when H1 Cooling is active, to prevent condensation while cooling, closing contact will stop cooling.

- Cool switch ☆ ☆

This selection is visible only when the cooling function is enabled from the H1 menu and activation is selected by the IN4 cool switch.

NOTE! If IN4 input is already in use, configuration is not possible!

H1 Options

Screen 4.2.5 on page 16

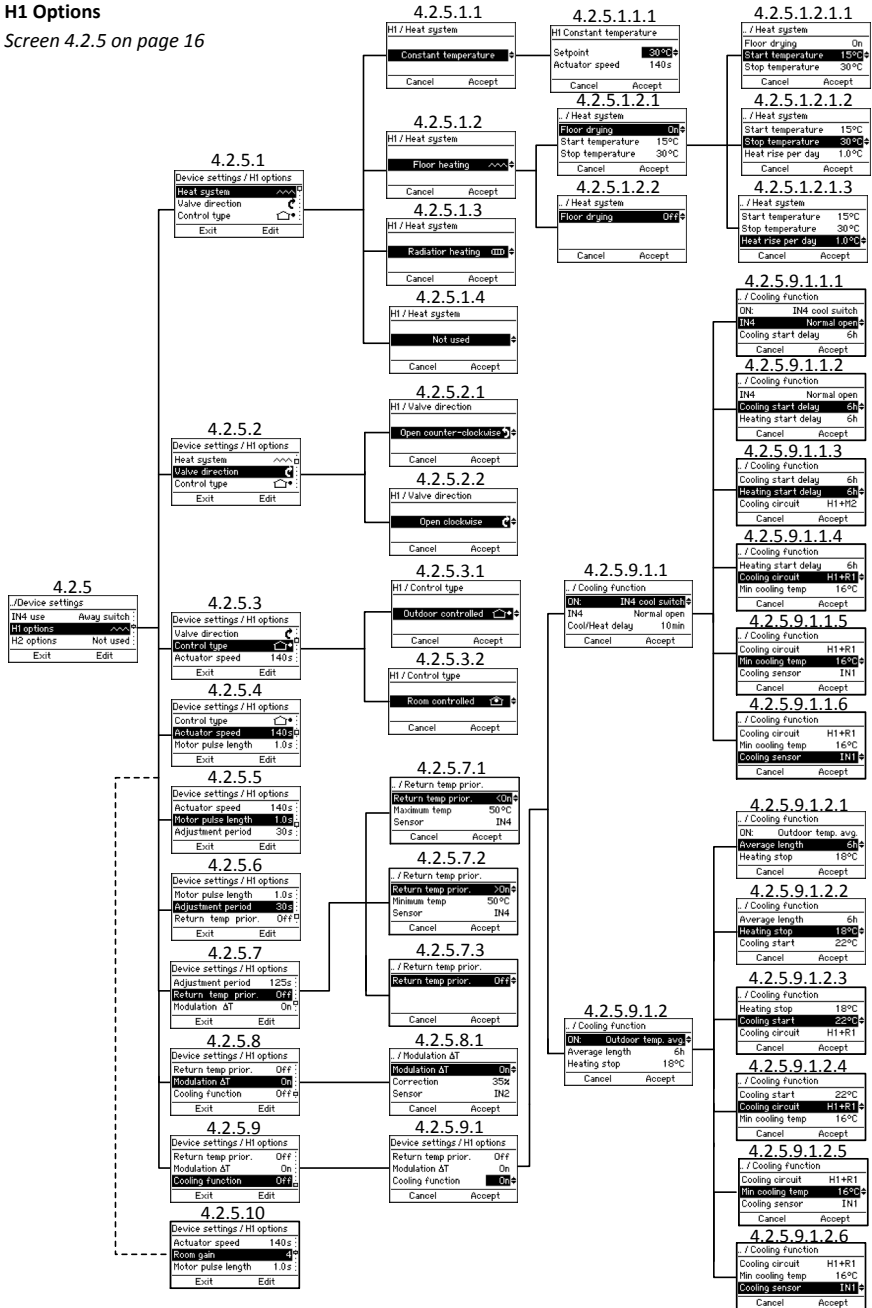

Heat system

Screen 4.2.5.1 on page 25

NOTE! If you change the heating type, all heating parameters will be reset to the default values!

You can choose heating system from 4 alternatives:

- **Constant temperature (CT)**

- 4.2.5.1.1

- Maintains constant supply water temperature.

- After you have chosen CT, you have to set "setpoint", the desired temperature of supply water, and actuator speed (default speed of standard delivery is 140 sec)

- **Floor heating**

- 4.2.5.1.2

- You can activate a **floor drying function** (4.2.5.1.2.1), that is in accordance with the standard EN1264-4.

- Start temperature (4.2.5.1.2.1.1) - set the supply water temperature setpoint when the drying starts
 - Stop temperature (4.2.5.1.2.1.2) - set the supply water temperature setpoint when drying stops
 - Heat rise per day (4.2.5.1.2.1.3) - set the daily change in supply water temperature setpoint

For example:

Start temperature = 15 °C, Stop temperature = 30 °C, Heat rise per day = 1 °C

>> Heating is started at 15 degrees, and the setpoint temperature is increased one degree a day until it reaches 30 degrees. After this, the setpoint temperature is decreased one degree per day until it reaches 15 °C.

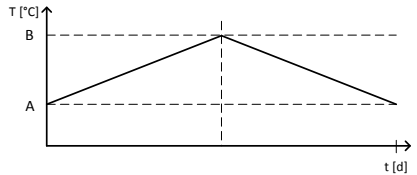

Floor drying function: A = Start temperature, B = Stop temperature

- **Radiator heating**

- 4.2.5.1.3

- **Not in use**

- 4.2.5.1.4

Valve direction

Screen 4.2.5.2

Set the rotation direction of the valve:

Opens clockwise (4.2.5.2.2) or counter-clockwise (4.2.5.2.1)

Control type

Screen 4.2.5.3

NOTE! If you change the control type, all heating parameters will be reset to the default values!

Set control type:

- **Outdoor controlled** 

- Screen 4.2.5.3.1

- With outdoor temperature controlled system, the supply water temperature depends on the outside temperature. Because of this you must set a heating curve which controls the supply water temperature according to outside temperature. You can find more information about heating curves on page 39.

- On the basic screen an underlined outdoor temperature is a sign of an outdoor controlled system.

- **Room controlled** 

Screen 4.2.5.3.2

If wireless room unit is in use, the system can be changed to be room controlled. In this case AM40 does not use heating curves and you can adjust the actual room temperature.

It is easy to adjust the room temperature by rotating the control wheel on the wireless room unit. More information on the wireless room unit on page 35.

On the basic screen an underlined indoor temperature is a sign of room controlled system.

Pack A – Wireless room unit and RF-transmitter // *Product no. 1140041 // EAN 6415843670558*

Actuator speed ☆

Screen 4.2.5.4 on page 25

Set the right actuator speed [sec/90 °] so that AM40 can control correctly. Speed can be set with a 1 second accuracy.

The default speed of standard delivery is 140 sec. In case of basic delivery do not make any changes to this option!

Room gain ☆

4.2.5.10 on page 25

Set the strength of room correction, when using room unit with AM40, default "4".

Motor pulse length ☆

4.2.5.5 on page 25

This function enables utilization of other than standard delivery motor units. You can set the motor pulse length with 0,1 second accuracy.

Default motor pulse length of standard delivery is 1 sec. In case of basic deliver do not make any changes to this option!

Adjustment period ☆

Screen 4.2.5.6 on page 25

You can set the adjustment period length with 1 second accuracy.

Default adjustment period is 125 sec. In case of basic delivery do not make any changes to this option!

Return temperature prioritization ☆

Screen 4.2.5.7 on page 25

This function enables prioritization of return water temperature.

You can set either a maximum (<On) or minimum (>On) limit for return water temperature:

<On:

You set the maximum limit for return water temperature below which the temperature will be kept and select the sensor that measures the temperature.

Suitable for example in district heating applications.

>On:

You set the minimum limit for return water temperature above which the temperature will be kept and select the sensor that measures the temperature.

For example

Drawing 10 on page 43

If the return water temperature (IN2 in the drawing) drops below the limit, the valve starts to close in order to keep return water temperature above the limit. This happens even if there is need for heating in the heating circuit.

If only one heating circuit is in use, you can choose whether to use input IN2 or IN4 for the

return water sensor. If two heating circuits are in use, only IN4 is possible

NOTE! If you use the IN4 input, you must configure the input according to the sensor type that you are using >> See “IN4 use” on page 23.

Modulation ΔT ☆ ☆

Screen 4.2.5.8 on page 25

This function enables modulating supply water temperature according to changes in the return water temperature.

This function is very useful especially in massive underfloor heating systems because it prevents overloading heavy floor structures, thus saving energy. This is based on the fact that return water temperature usually reacts to the temperature changes in heating circuit before there is any noticeable change in room temperature.

In “Correction” you set the strength of the modulation effect in percentages, default for underfloor heating is 35% and for a radiator system 20%.

./ Modulation ΔT	
Modulation ΔT	On
Correction	35%
Sensor	IN2
Cancel	Accept

In “Sensor” you choose the sensor input which is used for measuring the return water temperature. If only one heating circuit is in use, inputs IN2 and IN4 are available. If two heating circuits are in use, only IN4 is possible.

NOTE! If you use IN4 input, you must configure the input according to the sensor type that you are using >> See “IN4 use” on page 23.

For example

See drawing 1 on this page

If the return water temperature (IN2 in the drawing) rises because of the extra heat accumulated inside the house, the modulation function drops the supply water temperature.

The same works vice versa if there is extra need for heating in the house.

1. Heating circuit with return modulation in underfloor heating system.

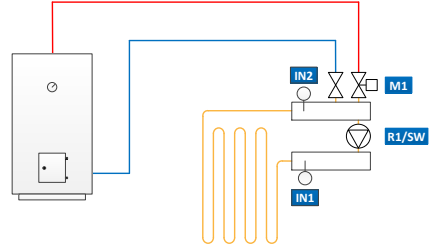

Cooling function ☆ ☆

Screen 4.2.5.9 on page 25

This function enables cooling in hydronic heating systems or by separate cooling modules such as ceiling cooling panels or Fan Coil unit.

After enabling the cooling function, you choose the method (“Outdoor temp. avg.” or “IN4 cool switch”) for how cooling is activated:

You can also change manually from heating to cooling or automatic from mode-button in main screen, see page 15, key3.

Outdoor temp. avg.:

Screen 4.2.5.9.1.2 on page 25

./ Cooling function	
On	Outdoor temp. avg.
Average length	5h
Heating stop	18°C
Cancel	Accept

Cooling is activated automatically by the average value of outdoor temperature:

- In “Average length” you set the length of the period for which the average outdoor temperature is calculated, default 24 h.
- In “Heating stop” you set the limit for outdoor temperature which the heating will be stopped, default 18 °C.
- In “Cooling start” you set the limit for outdoor temperature which the cooling will be started, default 22 °C.

- In "Cooling circuit" you select which heating circuit is used for cooling:
 - o H2 >> Circuit 2 is used for cooling. See drawings 2, 3 and 4 on page 30.
 - o H1+R1 >> The circuit used for heating is also used for cooling and R1 is used for switching between heating source and cooling source. See drawing 1 on this page.
 - o H1+M2 >> The circuit used for heating is also used for cooling and M2 is used for switching between heating source and cooling source. See drawing 1 on this page.
- In "M2 Open" You set opening direction of M2 in the above case, select clockwise or counter-clockwise
- In "Min cooling temp" you choose the minimum water cooling temperature, default 15°C.
- In "Cooling sensor" you choose the sensor used for measuring supply water temperature for cooling, default IN1.

IN4 cool switch:

Screen 4.2.5.9.1.1 on page 25

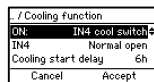

Cooling is activated by a signal connected to the IN4-input:

- In "IN4" you set the mode of the switch: normally open or normally closed. In case the mode is "normal open", cooling is activated as the switch closes and vice versa.
- In "Cooling start delay" you set the delay between switching off the heating and starting the cooling, default 8 hour.
- In "Heating start delay" you set the delay between switching off the cooling and starting the heating, default 6 hour.
- In "Cooling circuit" you choose which heating circuit is used for cooling:
 - o H2 >> Circuit 2 is used for cooling. See drawings 2, 3 and 4 on page 30.

- o H1+R1 >> The circuit used for heating is also used for cooling and R1 is used for switching between heating source and cooling source. See drawing 1 on this page.
- o H1+M2 >> The circuit used for heating is also used for cooling and M2 is used for switching between heating source and cooling source. See drawing 1 on this page.
- o M2 Open >> You set the opening direction of M2 in above case, select clockwise or counter-clockwise
- In "Min cooling temp" you choose the minimum water cooling temperature, default 15°C.
- In "Cooling sensor" you choose the sensor used for measuring supply water temperature for cooling, default IN1.
- If using "CT", constant temperature heating system, simply set the cooling water setpoint.
- If both heating circuits are in use, H1 can still be used for cooling by selecting "H1+R1". In this case you have to choose if H2 is used for heating while H1 is cooling. This may be the case if H2 is used for the bath room and sanitary facilities.

1. 1-circuit for heating and cooling, switched over by relay R1 or M2, regulation with same valve.

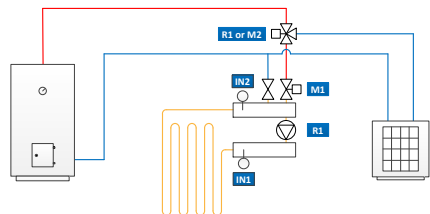

2. 1-circuit for heating and cooling. Regulated and switched over with own valves.

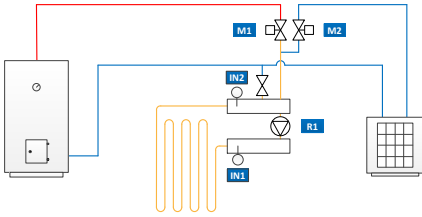

3. 1-circuit for heating and separate circuit for cooling. Regulated and switched over with own valves.

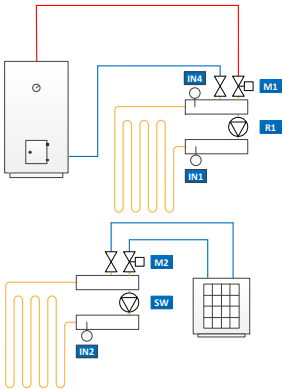

4. 1-circuit for heating and separate circuit for cooling by ceiling panels. Regulated and switched over with own valves.

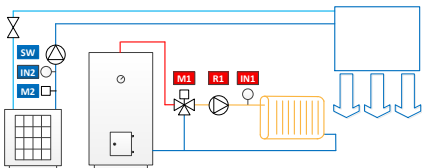

H2 Options

Screen 4.2.6 on page 16

Options for heating circuit 2 are the same as for heating circuit 1 **except** "Return temperature prioritization", " ΔT Modulation" and "Cooling function" are available only for heating circuit 1.

See "H1 Options" beginning from page 25

Outside temperature delay

Screen 4.2.7 on page 16

Enables slower supply water temperature reaction to outside temperature. This compensates for slow changing of temperature in thick structures. You set the delay in hours.

ECO-transition

Screen 4.2.8 on page 16

You can choose if you want the ECO transition to be independent or common for the heating circuits:

If you choose it to be **common**, ECO- and Holiday-modes will be activated for both heating circuits if you activate it for either heating circuit.

If you choose it to be **independent**, ECO- or Holiday-mode will be activated only for the heating circuit in question and the other heating circuit keeps its mode as it was.

More information about ECO and Holiday modes on page 33.

NOTE! Visible only if two heating circuits are in use!

Communication

Screen 4.2.9 on page 16

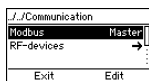

Modbus ☆

This function is relevant if AM50 is in use. AM50 is an extensive control system that includes many programs for various purposes like district heating.

RF-devices

You can check the number of added wireless room units and add a new one, see instructions “Adding a wireless room unit” on page 12.

Screens 4.2.9.2.1 and 4.2.9.2.1.1 on page 13

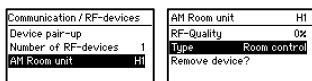

By entering paired unit, you can also:

- Check RF-Quality
You must set also room unit to RF-Quality check mode, see page 36.
- Change control type of room unit from room control to remote control.
In room control mode, the measured room temperature effects regulation
In remote control mode, the measured room temperature does not effect regulation. You may only adjust regulation with offset setting.
- Remove a wireless room unit

Information

Screen 4.2.10 on page 16

By choosing “Information” (4.2.10) you will access an information screen where you can check the following information of the system:

- Name of the application
- Software version
- Parameter version
- Hardware version
- Software version(s) of wireless room unit(s) (displayed only if room units are in use!)

Reset factory settings

Screen 4.2.11 on page 16

With this selection you can reset settings to the factory settings.

NOTE! Resetting factory settings resets all the parameters to the factory values.

Before resetting the controller write down old data (heating type, min/max values, valve direction, room unit, setpoints).

If you are not sure about these values, do not reset the controller

Alarms

Screen 4.3 on page 16

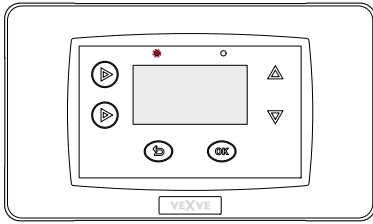

Blinking left-hand red LED on the AM40 CU is a sign of an active alarm.

In “Alarms” (screen 4.3) you can check which error causes the alarm. There can also be more than just one active alarm.

Inactive alarms are also listed in “Alarms”; they disappear only when you reset them.

Despite active alarms, AM40 continues controlling as long as it is possible. When the alarm has ended, AM40 continues its function the way it was before the alarm.

Error codes and required actions

IN1/IN2/IN3/IN4 sensor alarm

There is no communication between sensor and the AM40 CU or there is short-circuit in the sensor circuit.

>> Check that the sensor is connected and there is no mechanical failure in the sensor. If these measures don't help, sensor needs to be replaced.

In measurements (see page 18) and basic screens (see page 17) temperature of faulty sensor is shown with “- - -”.

Good to know: If supply water sensor is faulty, valve opening will automatically be set to 5 %.

Room Unit missing

>> Take the room unit to the AM40.

- Check that the RF transmitter is connected and that the cable is not damaged.
- Disconnect the power from the AM40 CU and then briefly remove one battery from the room unit.
- If the function is restored to normal when power is reconnected, return the room unit to its place after pushing the setup button on the backside of the room unit and selecting “RF”.
- Let the unit calculate the average radio communication value for a while. If the value is below 30%, check if you can improve signal strength by relocating the room unit nearby.
- The location of the RF transmitter can also affect the range of radio communication significantly

Always locate the RF transmitter as high as possible and away from power cables.

Low Energy

The valve has been fully open for more than 15 minutes, but the supply water temperature is still 5°C below the desired temperature.

This may be caused by a burner fault, or if the water heater cannot provide hot enough water for the heating network.

High energy

The valve has been closed for more than 15 minutes, but the supply water temperature is still above the set maximum temperature and at least +5°C above the indoor temperature.

The valve cannot be closed mechanically or, when using constant temperature control, the accumulator tank is full and even the return water exceeds the set limit.

ECO and Holiday modes

ECO and Holiday modes enable easy energy saving: You can for example drop room temperature for the time you are not at home.

ECO mode is designed for adjusting the temperature temporarily, for example for decreasing the temperature during a workday.

HOLIDAY mode is designed for longer-term temperature adjustment, for example the duration of a holiday or indefinitely.

ECO External is a mode that you switch on with an external switch connected to input IN4. This mode uses the temperature values of the Holiday mode and it remains on until you switch it off.

For example:

Pack D – GSM module//product no. 1140044

>> You can switch on the ECO External mode with an SMS.

NOTE! You can of course use the modes also for increasing the room temperature!

Activating the modes

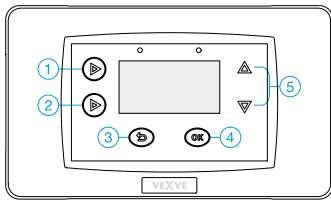

Both modes can be switched on by pressing key 2 while you are in the basic screen:

- ECO mode with a **short** push. Text “ECO” appears to the top of the screen when mode is switched on.

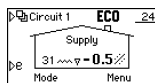

- Holiday mode with a **long** push (more than

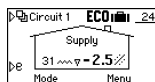

3 seconds). Text “ECO” and a suitcase symbol appear to the top of the screen when the mode is switched on.

Both modes can be cancelled by pressing shortly key 2.

You can also change mode by pressing key 3 once in the basic screen to reach “Select mode”. There you can see the values of ECO, Holiday and Normal modes. You can browse modes with Up/down keys (5) and switch on a selected mode with OK key (4).

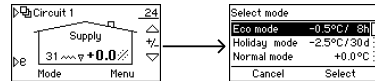

If there are two heating circuits in use, you can choose if ECO and Holiday modes are switched on separately or together for the circuits, see “ECO-transition” on page 30.

NOTE! You can also use the wireless room unit to switch on ECO and Holiday modes, see page 35.

Changing the mode values

You can change ECO and Holiday mode values in the “Circuit Menu”.

You can access this menu by pressing the OK key (4) while you are in the basic screen. Scroll the menu with up/down keys (5) to reach ECO and Holiday modes.

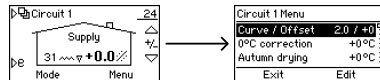

NOTE! If two heating circuits are in use, you will move from the basic screen of circuit 1 to “Circuit 1 Menu” and from the basic screen of circuit 2 to “Circuit 2 Menu”. You can move from basic screen 1 to basic screen 2 by pressing key 1 once.

Circuit 1 Menu	
Max Limit	35°C
Eco mode	19.5°C / Sh
Holiday mode	18.5°C / 30d
Cancel	Accept

When you have selected the mode of which values you want to change, press OK

key (4) to edit the values. Scroll values with up/down keys (5) and confirm selection with OK key (4).

- In case you have wireless room units, you set the actual room temperature: from +5.0 °C up to +30.0 °C
- In case you don't have wireless room units, you set a change in room temperature: from -9.0 °C up to +9.5°C
- In case control type is "Constant temperature" you set a new water temperature

If you drop the temperature as much as possible, you reach an "OFF" function which means that heating turns off: Valve closes and pump shuts down.

- If outdoor temperature is less than +0,5 °C, the pump will not shut down and valve will not close but the heating circuit will run with the minimum parameters:

After you have set the mode temperature, you move to duration selection where you choose how long the mode stays on after it is switched on:

- ECO: 1 - 9 hours
- Holiday: 1 – 30 days or ∞ = indefinitely

Using the room unit

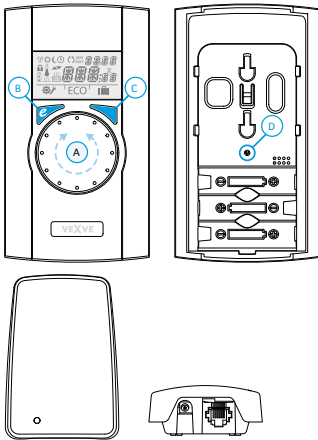

Pack A – Wireless room unit and RF-transmitter//
Product no. 1140041

Instructions for adding a wireless room unit on
page 12.

NOTE! All the changes that you make on the wireless room unit will be copied to the AM40 CU with a slight delay.

Adjusting the temperature

You can adjust the temperature by rotating the knob (A) on the default screen: for floor and radiator heating (LO and HI) you adjust the indoor temperature and for constant temperature control (CT) you adjust the supply water temperature. The set temperature will blink five times on the display, and then it will become effective. You can also confirm the setting by pushing Enter (C).

Info about changing outdoor control to indoor control can be found on pages 26 and 27

ECO and Holiday modes

The ECO button (B) can be used for switching on the ECO and HOLIDAY modes.

ECO mode is designed for adjusting the temperature temporarily, for example for decreasing the temperature during a workday. Of course, the function can also be used for increasing the temperature temporarily.

HOLIDAY mode is designed for longer-term temperature adjustment, for example for the duration of a holiday or indefinitely.



ECO mode can be switched on by a single push of the ECO button (B). When ECO mode is switched on, its duration is displayed in the upper right-hand corner for 20 seconds.



HOLIDAY mode can be switched on by pushing and holding the ECO button (B) for more than three seconds. When HOLIDAY mode is switched on, its duration is displayed in the upper right-hand corner for 20 seconds.

ECO External is a mode that you switch on with an external switch connected to input IN4 in the AM40 CU. If the mode is on, its symbol is visible on the display of the wireless room unit.

More information about ECO and Holiday modes on page 32.

Measurements

Pushing the Enter button (C) once displays a quick menu that shows the measured indoor, supply water and outside temperatures, IN2 and IN4 measurements (if they are in use), calculated supply water set point, and valve opening. The menu can be navigated with the rotating knob (A) or one step at a time with the Enter button (C).

User menu

Pushing and holding the Enter button (C) for more than three seconds opens the user menu. The menu can be navigated with the rotating knob (A), and the Enter button (C) activates the current selection. After this, the value to be adjusted will blink on the display. A blinking value can be changed with the rotating knob (A), and the selection is confirmed with Enter (C).

in the user menu you can check and change following data:

- Minimum and maximum limits for supply water temperature
 - o Not available if heating type is constant temperature!
- Time [hh:mm]
- Weekday:
 - o 1 = Monday, 5 = Friday, 7 = Sunday
- Settings of Eco mode
 - o Temperature and duration
- Settings of Holiday mode
 - o Temperature and duration
- Backlight settings
 - o ON/OFF
- When cooling function is activated you can choose manual heating / cooling or automatic mode

The following data can only be checked in the user menu:

- Software version of AM40 CU
- Software version of room unit

Push the ECO button (B) to leave the menu.

If the device is not used for one minute, it will automatically return to the default screen.

Setup menu

Use a ballpoint pen to push the Setup button (D) on the back panel to access the setup menu.

Rotate the knob (A) to navigate the functions and push the Enter button (C) to modify an option. Select the desired value by rotating the knob (A).

Values that can be changed will blink on the display, and the changes are confirmed by pushing the Enter button (C).

Settings in setup mode:

Mode

Heating type:

- Floor heating (LO) - You can also activate a floor drying function (DRY), see page 25 "Floor heating"
- Radiator heating (HI)
- Constant temperature (CT), see page 25 "Constant temperature (CT)"

Valve direction

Opens in the clockwise or the counter-clockwise direction. The default direction is clockwise.

Note the arrow on the display!

RF

RF indicates the calculated average radio signal strength.







Recommendation: Should be over 50 %!







DEFA



DEFA resets the default settings!

NOTE! The DEFA option also resets the radio connection between room unit and the AM40 CU!

Symbols on the room unit display

Top row symbols		room unit is transmitting or receiving data
		daytime program
		night-time program
		weekly programming
		rotation direction of the valve (opens clockwise or counter-clockwise)
	MIN MAX	displayed in connection with the supply water temperature limits
		additional annotations such as "OK". These are used to display function durations. CT - constant temperature control COOL / HEAT / AUTO – When cooling is activated

Middle row symbols		1/3 of the battery capacity left. When this symbol is displayed, you should install new alkaline AA batteries in the room unit. The room unit has a memory that stores the system settings while the batteries are being replaced.	
		Measured temperature	
		floor heating	The heat symbol of three wavy lines is displayed when heating is required. In the summer, the when the controller has closed the valve, lines disappear
		radiator heating	
		NOTE! The letters "CT" at the top of the display indicate constant temperature control.	
		additional annotations for displaying the desired temperature at 0.5 degree intervals.	
		radio signal strength	

Bottom row symbols		user menu
		setup menu
	ECO	ECO mode
		HOLIDAY mode

Fault codes of the wireless room unit

ERR^{T1} ERR^{T2} ERR^{T4} ERR^{OUT}

There is no communication between sensor and the AM40 CU or there is short-circuit in the sensor circuit.

>> Check that the sensor is connected and there is no mechanical failure in the sensor. If these measures do not help, sensor needs to be replaced.

Good to know: If supply water sensor is faulty, valve opening will automatically be set to 5 %.

ERR^{RF}

See "Room Unit missing" on page 32.

ERR^{SYS}

Set the switch on the front side of the motor unit to manual operation (hand symbol) and check the operation of the valve. The fault is not mechanical if the valve can easily be turned 90 degrees. After this, check if the device works normally. Remember to return switch D into the "A" position.

If the problem persists, contact a Vexve retailer.

ERR^{LOW}

The valve has been fully open for more than 15 minutes, but the supply water temperature is still 5°C below the desired temperature.

This may be caused by a burner fault, or if the water heater cannot provide hot enough water for the heating network for example.

ERR^{HIGH}

The valve has been closed for more than 15 minutes, but the supply water temperature is still above the set maximum temperature and +5°C above the indoor temperature.

The valve cannot be closed mechanically or, when using constant temperature control, the water heater is full and even return water exceeds the set limit.



Battery power is low.

>>Install new alkaline AA batteries in the room unit.

The room unit has a memory that stores the system settings while the batteries are being replaced.

When the battery is low, the backlight is off and the display is clear when the device is not in use.

Heating curve

In case of an outdoor temperature controlled system, the supply water temperature depends on the outside temperature. Because of this you must set a heating curve which controls supply water temperature in relation to outside temperature, see diagram “Outside temperature vs. supply water temperature” on page 41.

If the curve is set well, indoor temperature remains constant even if the outside temperature changes. The right form of the curve depends on many things, such as insulation, heating system, age of the house, etc. Because of this it is not possible to tell precisely the right form of the curve in advance.

In principle you can say that old houses need higher curves than newer ones and radiator heating needs a higher curve than floor heating.

In case of high curves, the supply water temperature is higher and a change in outside temperature causes a bigger change in supply water temperature than in case of lower curves.

Example

See diagram on page 41.

Temperature drops from 0 degrees to -5 degrees. According to curve 4 supply water temperature rises from 35 degrees to 38 degrees ($\Delta T_s = 3 \text{ }^\circ\text{C}$). According to curve 9.5 supply water temperature rises from 75 to 83 degrees ($\Delta T_s = 8 \text{ }^\circ\text{C}$)

Setting heating curve

You can change curve settings in “Circuit menus”. You can access menus by pressing the OK key (4) on the basic screen.

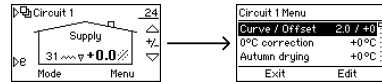

NOTE! If control type is “room controlled” or heating type is constant temperature (CT), AM40 does not use a heating curve and therefore curve settings are not visible in the circuit menus!

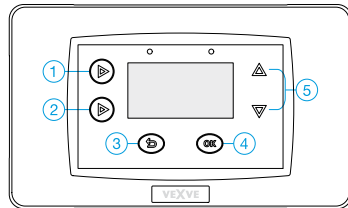

- In “Curve/Offset” you choose the curve and set its offset.
- There are three steps for setting the heating curve:
 - Start point**
Summertime outdoor temperature (5 - 20 °C) and corresponding supply water temperature at the starting point of the curve.
 - Stop point**
Wintertime outdoor temperature (-5 - -30 °C) and corresponding supply water temperature at the ending point of the heating curve

Graphical view

Choose curve (0.2 – 9.5) with keys 1 and 2 on the left side of the AM40 CU. Curves from 0.2 to 5.0 can be chosen in steps of

size 0.2 and curves from 5.0 to 9.5 in steps of 0.5. The bigger the number of the curve, the higher the curve. Default curve for floor heating is 2 and for radiator heating 4.

With up/down keys (5) on the right side you can set offset of the curve. This means that you move the curve up or down as a whole without changing its gradient. **Offset should be used if the room temperature remains constant but is constantly too high or low.**

Example

See diagram below

The unbroken line is the heating curve 4 and the broken line above it is also the same curve but with fine-tune of value 5 degrees.

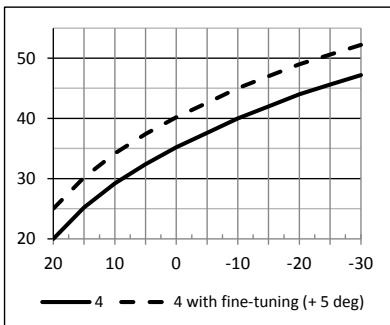

- In "0 °C correction" you can set a local offset correction to the curve. The correction is active in outdoor temperature range from -5 °C to +5. This function dries structures and so reduces inclemency. You set the amount of offset yourself (0 – 5 °C).
- "Autumn drying" function raises the supply water temperature automatically for a certain time period when outside temperature has been cold enough for long enough. This reduces moisture in

structures and decreases so also inclemency which is a common problem in the early autumn.

- In "Min Limit" and "Max limit" you can set limits for supply water temperature.

What to do if....

- **room temperature is constantly too low or too high?**
You have to set an offset to the curve >> While you are in the basic screen, press up/down keys (5) – up key if it's too cool and down key if it's too warm
- **room temperature is too low or too high during a cold period?**
You have to choose a different curve >> Move to "Circuit menu" by pressing the OK-key (4) twice. Select a curve with keys 1 and 2 on the left side of the AM40 CU. Select a higher curve if it is too cool or a lower curve if it is too warm.
- **room temperature is too high or too low during a warm period?**
If the temperature is too high: lower the offset and raise the curve.
If the temperature is too low: Raise the offset and lower the curve

NOTE! It takes time, from some hours up to one day, before the changes that you make to the curve are noticeable in the room temperature!



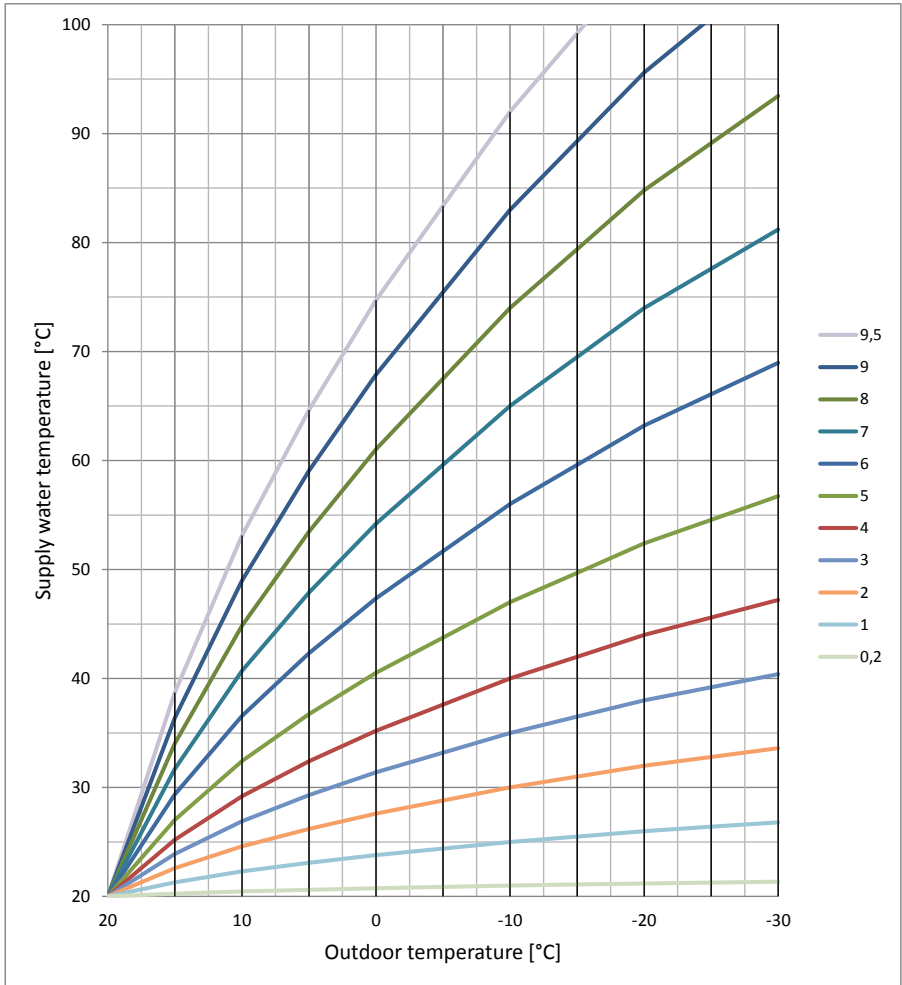







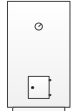
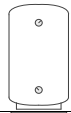



Outside temperature vs. supply water curve



Applications

Here you find schemes of some possible uses of AM40.

Symbols

	Boiler
	Accumulator
	Fireplace
	Radiator heating circuit
	Floor heating circuit
	Domestic hot water spiral
	Three-way valve with actuator (E.g. Vexve AMV3 series)
	Four-way valve with actuator (E.g. Vexve AMV4 series)
	Bivalent valve with actuator (E.g. Vexve ABV4 series)
	Pump
	Supply or return water sensor •
	Connector for temperature sensors (IN1/IN2/IN3/IN4) in AM40 CU • Red for heating circuit 1 (H1), blue for heating circuit 2 (H2)
	Relay control. Red = H1, Blue = H2
	Extra micro limit switch • Red = H1, Blue = H2
	Motor unit • Red = H1, Blue = H2
	Solar collector

• See "Accessories" on page 5 for product recommendations

1. Basic 1-circuit

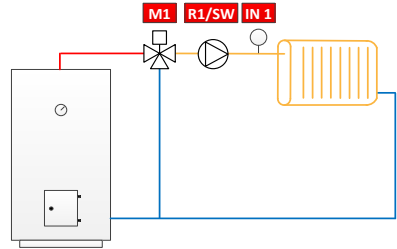

2. Basic 2-circuit

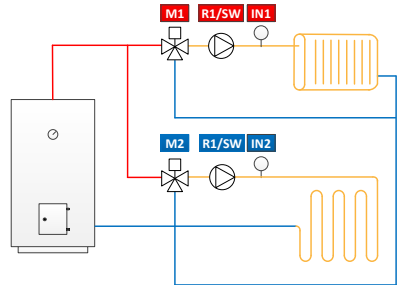

3. 1-circuit and BIO-loading

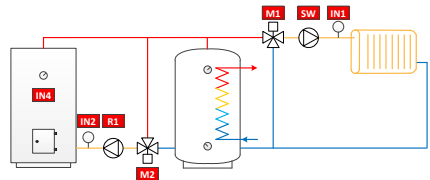

4. 1-circuit and SimpleSolar

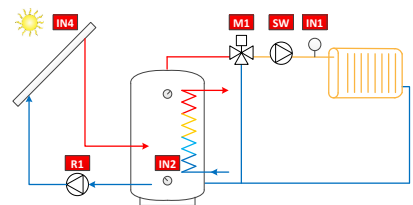

5. 1-circuit and Fireplace

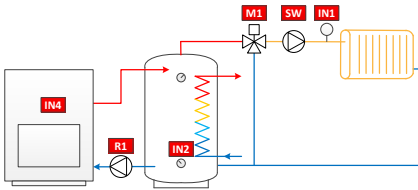

6. 1-circuit and DHW VC

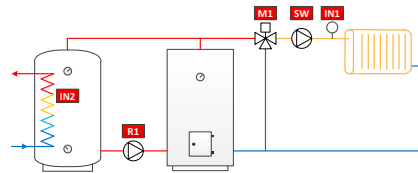

7. 1-circuit and DHW VO

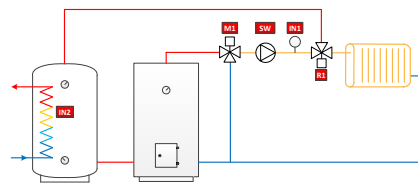

8. 2-circuit and DHW VC

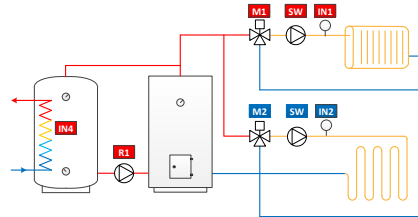

9. 2-circuit and DHW VO

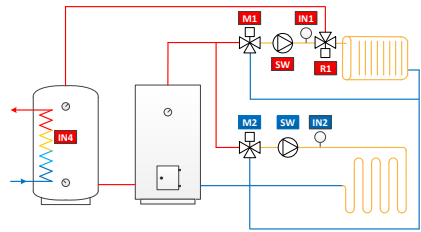

10. 1-circuit and Priority

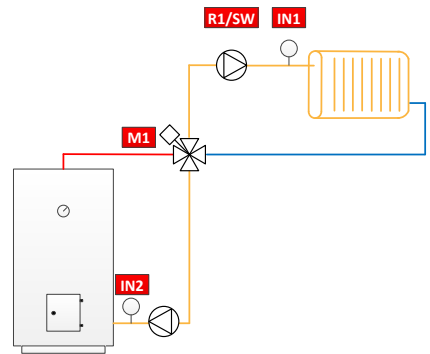

11. 1-circuit and Priority and DHW VC

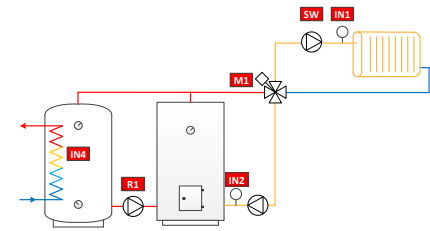

12. 1-circuit and priority and DHW VO

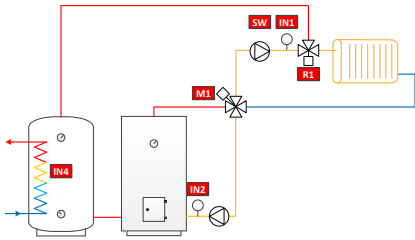

13. Fireplace and 2 tanks

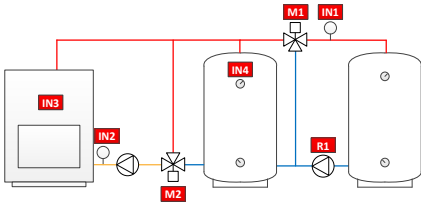

14. Bivalent valve and Solar

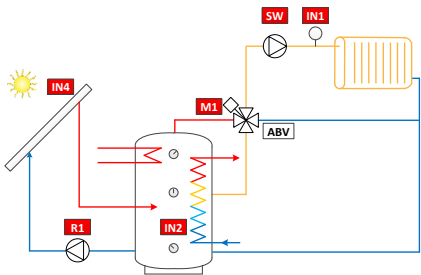

15. Bivalent valve and Solar & Boiler

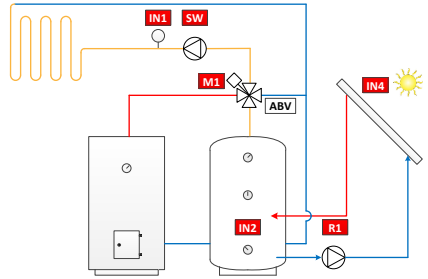

16. 1-circuit and bioloading with priority

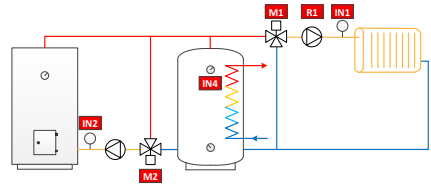

17. 1-circuit and burner control

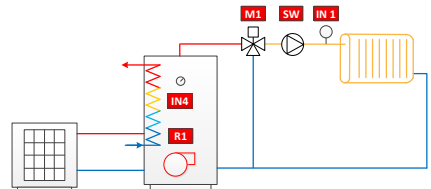

Quick setup guide

1. Set the valve and actuator to the zero position and check the direction of the valve rotation (default setting is that valve opens clockwise).
2. Install the adapter on the valve stem and, if necessary, put the pin in place. Fasten the actuator in place by using the provided long screw.
3. Set the switch on the front side of the motor unit to manual operation (hand symbol) and check that the combination works properly and easily. Set the motor unit switch to automatic operation (A).

4. Connect motor unit of heating circuit 1 to M1 connector.

If there are two heating circuits in use, connect the motor unit of heating circuit 2 into M2 connector.

5. Place the supply water sensor to pipeline about 5- 50 cm from mixing valve using pipe attachment ties. Attach the sensor cable to the IN1 connector.

If heating circuit 2 is in use, place the sensor the same way to the pipeline and connect sensor cable to the IN2 connector.

6. Attach the outdoor temperature sensor to a suitable place on an outer wall using the wall mount box. Choose a sheltered location for the sensor: northern wall, no direct sunlight, snow or rain to sensor box. Attach the sensor cable to the IN3 connector.
7. Attach AM40 control unit with included assembly parts to a convenient location.

8. Power on the AM40 CU.

9. The device asks for basic information. Browse the options with the up/down keys on the right side of AM40 CU and confirm selections with OK key. With the cancel key (left hand button below the display) you can move backwards in the menus.

Set information:

- Language
- Time
- Date
- Heating circuit 1 options:
 - o Heat system (constant temperature /floor heating /radiator heating/not used)
 - o Control type (outdoor controlled or constant supply water temperature CT)*
 - o Maximum and minimum limits for supply water temperature*
 - o Heating curve settings*
 - >>1. Set the starting point of the curve (T_{out} , T_{supply})
 - 2. Set the ending point of the curve (T_{out} , T_{supply})
 - 3. Graphical view: Shows the curve which AM40 has calculated based on the given starting and ending points. You can choose curve with the keys on the left side of the AM40 CU. With up/down keys on the right side you can set offset of the curve. For more information see page 39.
 - o Valve direction (opens clockwise/counter-clockwise)
- Heating circuit 2 options:
 - o Same as for heating circuit 1

After these steps you will move to basic screen of heating circuit 1, more information on page 15.

* Not available if heat system is "constant temperature"

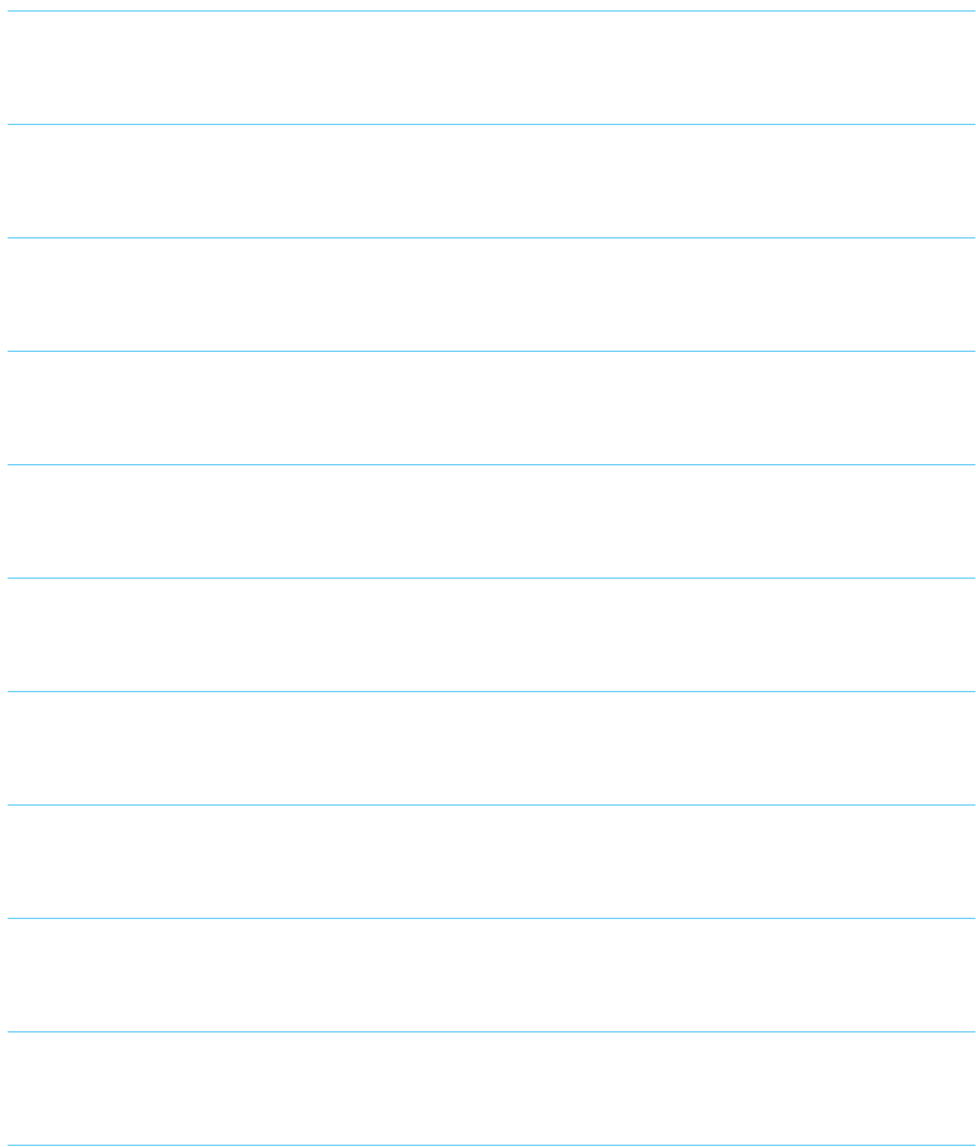



Vexve Oy

Pajakatu 11
FI-38200 Sastamala, Finland

vexve.customer@vexve.com
www.vexve.com

